



2024

MOTORSPORT  
COLLECTION



IN MOTORSPORT SINCE 1964



# INDEX INDICE



**04 > SAFETY AND QUALITY**  
*QUALITÀ E SICUREZZA*

**06 > 60 YEARS OF PASSION**  
*60 ANNI DI PASSIONE*

**08 > PARTNERSHIPS**  
*COLLABORAZIONI*

**10 > DRIVER**  
*PILOTA*

**22 > MECHANIC**  
*MECCANICO*

**28 > SEATS**  
*SEDILI*

**36 > STEERING WHEELS**  
*VOLANTI*

**58 > ADVERTISING AND EVENTS**  
*COMUNICAZIONE ED EVENTI*





# SAFETY AND QUALITY

## QUALITÀ E SICUREZZA

### HOW TO VERIFY THE AUTHENTICITY OF MOMO STEERING WHEELS

When purchasing a product, quality and authenticity are essential and vital conditions for every customer. MOMO, always fighting against forgery and safeguarding the Made In Italy brand, starting from spring 2021 has introduced the advanced NFC (Near Field Communication) technology for the first time ever in the steering wheels world, by applying it to its products and making them capable of communicating with the buyer. Thanks to NFC it will be possible to verify in real time the genuinity of a MOMO steering wheel directly from your own compatible smart devices (smartphone, tablet, smartwatch, etc); you will also have access to exclusive contents, directly released by MOMO, reserved to whom will register their own original MOMO steering wheel. NFC technology's potential is enormous and constantly evolving, giving the possibility to enrich the value and the features of the MOMO's steering wheel range.

The chip, in most of the steering wheels' range, is hidden in the right section in the back, near the handle. The chip's detection is reached just approaching the compatible device in proximity of the mentioned area. Every MOMO's steering wheel comes with a warning label, in its packaging, with the user manual and the exact indication of the chip's placement depending on the steering wheels model.

100% HAND MADE IN ITALY

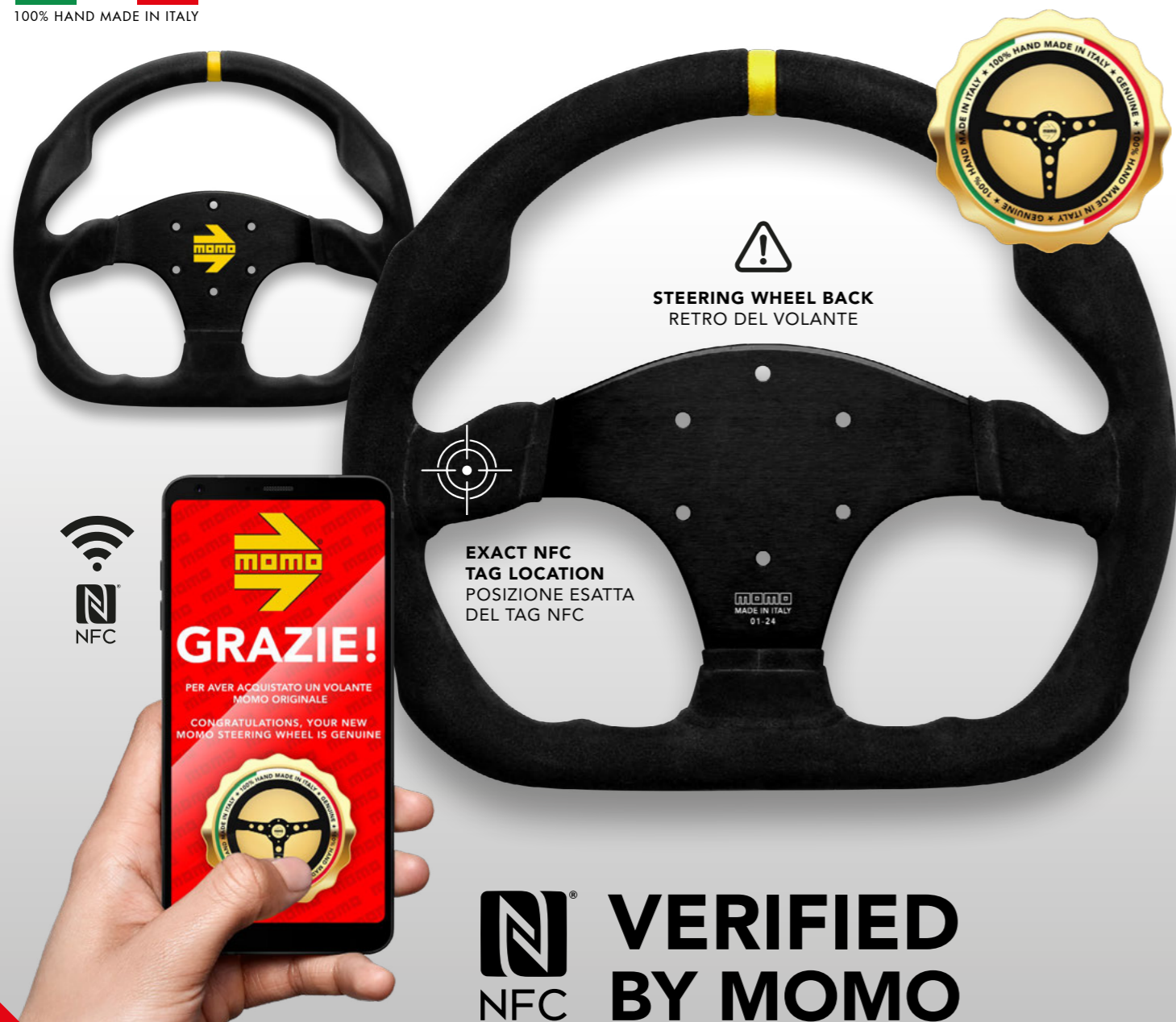

NFC **VERIFIED BY MOMO**

### COME VERIFICARE L'AUTENTICITÀ DEI VOLANTI MOMO

Nell'acquisto di un prodotto, qualità ed autenticità sono requisiti fondamentali e imprescindibili per ogni consumatore. MOMO, da sempre in lotta contro la contraffazione e per la tutela del Made in Italy, a partire dalla primavera 2021 ha introdotto l'avanzata tecnologia NFC (Near Field Communication) per la prima volta nel mondo dei volanti, applicandola ai propri e rendendoli capaci di comunicare con l'acquirente. Grazie al chip NFC sarà possibile verificare in tempo reale la genuinità del volante MOMO direttamente dai propri dispositivi smart compatibili (smartphone, tablet, smartwatch, etc); si avrà inoltre accesso ad esclusivi contenuti extra direttamente rilasciati da MOMO e riservati a chi registrerà il proprio volante MOMO originale. Le potenzialità della tecnologia NFC sono infinite ed in continua evoluzione, dando la possibilità di accrescere sempre più le funzionalità e il valore dei volanti MOMO.

Il chip, nella maggior parte dei volanti, è occultato nella parte posteriore destra in corrispondenza della guancetta. Il riconoscimento del chip avviene avvicinando il dispositivo compatibile al volante, in prossimità della zona indicata. Ogni volante MOMO è accompagnato, all'interno dell'imballaggio, da un foglietto illustrativo con le istruzioni per l'utilizzo e con l'indicazione puntuale del posizionamento del chip a seconda del modello.

# MOMO

FIA APPROVED

### FIA INDUSTRY WORKING GROUP

From the racetrack to the street, MOMO has kept valid every single requirement of quality, safety and design innovations, providing its customers with passion and expertise year after year: the MOMO brand represents a solid guarantee both in the tuning and motorsport accessories, and in the alloy wheels market. MOMO is part of the FIA Industry Working Group (IWG), consisting of companies involved in the development of future FIA standards and regulations. Membership in the IWG allows, among other things, to benefit from a privileged channel with the Federation, and receiving information about future research projects. "Driving Passion" is not only a slogan: it is the philosophy which endows every single step of MOMO's production process and which, rather than fading away, will always be MOMO's incentive to pursue quality and innovation.

### FIA INDUSTRY WORKING GROUP

Dalla pista alla strada, MOMO ha mantenuto saldi i requisiti di qualità, sicurezza e innovazione nel design mettendo la sua passione e la sua perizia al servizio dei propri clienti anno dopo anno: il marchio MOMO rappresenta una solida garanzia sia nel campo degli accessori tuning, sia in quello dei prodotti di abbigliamento motorsport e dei cerchi in lega. MOMO fa parte del FIA Industry Working Group (IWG), composto dalle aziende incaricate dello sviluppo di futuri standard e regolamenti FIA. L'affiliazione all'IWG consente, tra le altre cose, di beneficiare di un canale privilegiato con la Federazione, per ricevere informazioni sui futuri progetti di ricerca. "Driving Passion" non è solo uno slogan: è la filosofia che permea ogni step della produzione MOMO e che continuerà a guidare l'azienda in futuro, alla ricerca di eccellenza e innovazione.

[fia.com/fia-industry-working-group](https://fia.com/fia-industry-working-group)

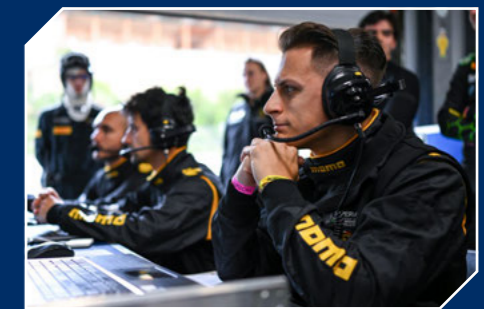



# 60 YEARS OF PASSION

## 60 ANNI DI PASSIONE

This year we celebrate 60 years of MOMO's history. Founded in 1964 by Gianpiero Moretti, who revolutionized racing with the first MOMO steering wheel, whose innovation propelled John Surtees to win the 1964 F1 World Championship. Through the years MOMO diversified its range introducing alloy wheels and street steering wheels, and collaborated with iconic automakers like Ferrari and legendary drivers including Michael Schumacher and Ayrton Senna. In 1993, the MOMO Corse department was established, specializing in flame-resistant clothing for racing drivers, solidifying MOMO's presence in motorsports. On its 60th anniversary, MOMO reflects on its eventful journey and looks ahead to a future defined by continued innovation and dedication to quality and performance.

Quest'anno celebriamo i 60 anni di storia di MOMO. Fondata nel 1964 da Gianpiero Moretti, il quale ha rivoluzionato il mondo delle corse con il primo volante MOMO, la cui innovazione ha contribuito alla vittoria di John Surtees nel Campionato del Mondo di F1 del 1964. Nel corso degli anni, MOMO ha diversificato la sua gamma introducendo cerchi in lega e volanti per veicoli stradali, e collaborando con iconici produttori automobilistici come Ferrari e piloti leggendari come Michael Schumacher e Ayrton Senna. Nel 1993, è stato istituito il reparto MOMO Corse, specializzato in abbigliamento ignifugo per piloti, e consolidando la presenza di MOMO nel motorsport. In occasione del suo 60° anniversario, MOMO riflette sul suo intenso percorso e guarda al futuro con la continua innovazione e la ferma dedizione alla qualità e alle prestazioni.





# PARTNERSHIPS

## COLLABORAZIONI

MOMO is proud to be the main supplier of Motorsport teams racing in different categories all over the world: GT World Challenge Europe, Italian GT Championship, Radical Cup Sweden, Dakar Rally, WRC, EuroNASCAR, Rally Legend and more. MOMO provides every single driver with the highest quality suits and accessories, produced by the greatest experts in the field, and compliant to the most recent FIA homologation requirements. Not only drivers: MOMO has a comprehensive range of mechanic and teamwear products, with many possibilities of customization.

MOMO è fiera di essere il principale fornitore di team racing che gareggiano in tutto il mondo in diverse categorie: GT World Challenge Europe, Campionato Italiano GT, Radical Cup Sweden, Rally Dakar, WRC, EuroNASCAR, Rally Legend e molto altro. MOMO fornisce a ogni singolo pilota tute e accessori della massima qualità, prodotti dai più grandi esperti nel campo, e conformi ai più recenti requisiti di omologazione FIA. Non solo piloti: MOMO ha una vasta gamma di prodotti per meccanici e teamwear, con molte possibilità di personalizzazione.



**IMPERIALE**  
SPORT CAR SERVICE  
RACING & REPAIR



**GEBHARDT**  
MOTORSPORT



**KallioKoski**  
MOTORSPORT



**JLC RACING**  
JESSE-LUC CECCALDI RACING



**CE DEALER TEAM**  
by Volvo Construction Equipment



**movisport**



**RADICAL**  
MOTORSPORT



**RR**  
RELA RACING



**KIC MOTORSPORT**



**HK RACING**



**Milwaukee**  
Rally Cup Czech Republic 2023



**Don's Touch Racing**



**TOP CARS**



**BASEBONE**



**BMC**  
Racing



**NTR**  
TEAM



**essecorse**



**JFE-18**  
Racing

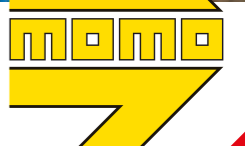



# DRIVER PILOTA

MOMO's iconic Italian style finds its full expression in the motorsport driver apparel collection, featuring garments with innovative and essential designs, available in various colors and sizes. All MOMO driver apparel items comply with the latest FIA 8856-2018 homologation and are crafted using the highest quality technical materials. Our range of driver motorsport clothing also offers endless customization possibilities, fully letting MOMO drivers express their creativity on the track, while maintaining the highest standards of quality and safety.

L'iconico stile italiano di MOMO trova la sua piena espressione nella collezione di abbigliamento da motorsport per pilota, con capi dal design innovativo ed essenziale, disponibili in diversi colori e taglie. Tutti i capi di abbigliamento per pilota MOMO sono conformi all'omologa FIA 8856-2018 e vengono realizzati con materiali tecnici di altissima qualità. La nostra gamma di abbigliamento motorsport fornisce inoltre infinite possibilità di personalizzazione, per garantire ai piloti MOMO di esprimere la propria creatività sulla pista, ma sempre mantenendo i massimi standard di qualità e sicurezza.



12 > SUITS  
TUTE

16 > FIRE PROOF UNDERWEAR U.S  
MAGLIERIA IGNIFUGA

18 > GLOVES  
GUANTI

20 > SHOES  
SCARPE

26 > SIZE CHARTS  
TABELLE TAGLIE

MEP Steel

SAMMUTEC

Hwoy  
www.hwoy.fi

POWER OIL

9 LIVES







MANUFACTURER: MOMO  
MODEL: MyMOMO  
HOM. NO. DC.379.23-O  
FIA STANDARD: 8856-2018

# UNLEASH YOUR IMAGINATION!



UNLIMITED CUSTOMIZATION WAY THANKS TO  
THE TOTALLY PRINTED DESIGN.

POSSIBILITÀ DI PERSONALIZZAZIONE ILLIMITATA  
GRAZIE AL DESIGN TOTALMENTE STAMPATO.



Embark on a journey of self-expression and individuality, and let MOMO's Design Department create you and your team the perfect customized suit: MyMOMO. Manufactured to the driver's measurements and specifications, MyMOMO is completely customizable: choose the design, colors, logos, and even specific features like pockets or belts, adding a boot cuff, or even a navigator pocket. Our state-of-the-art sublimation printing technology adheres to the stringent FIA 8856-2018 homologation rules, ensuring both style and safety. MyMOMO transforms the conventional into the extraordinary, offering a canvas for your creativity: it is a statement, a representation of your individuality in the fast-paced world of motorsports. To bring your vision to life, contact us now at [custom@momo.it](mailto:custom@momo.it).

With MyMOMO, the only limit is your imagination!

Imbarcati in un viaggio di espressione personale e individualità, e lascia che il reparto Design di MOMO crei per te e il tuo team la perfetta tuta personalizzata: MyMOMO. Realizzata sulle specifiche misure del pilota, la tuta MyMOMO è completamente personalizzabile: scegli il design, i colori, i loghi e persino caratteristiche specifiche come tasche o cinture, aggiungendo polsini e cavigliere o persino una tasca da navigatore. La nostra avanzata tecnologia di stampa sublimatica è conforme alle rigorose regole di omologazione FIA 8856-2018, garantendo sia stile che sicurezza. MyMOMO trasforma il convenzionale in straordinario, offrendo una tela per la tua creatività: è una dichiarazione, una rappresentazione della tua individualità nel frenetico mondo del motorsport. Per dare vita alla tua visione, contattaci ora su [custom@momo.it](mailto:custom@momo.it)

Con MyMOMO, l'unico limite è la tua immaginazione!

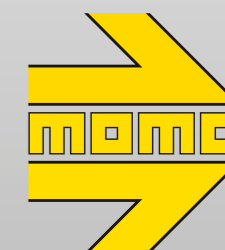





48  
64

LAYERS  
STRATI  
3



TUPROLTNNV00

NIGHT NAVY / ORANGE  
BLU NOTTE / ARANCIONE

## DRIVER SUITS TUTE PILOTA

Top-quality nomex fabric and compound  
Extremely lightweight  
Thin 3 layers compound  
Maximum wearing comfort  
Silicone side bands and logos  
9 standard sizes available  
Clean design for wide customization possibilities  
100% hand made in Italy  
Homologation: FIA 8856-2018  
Colours: night navy/fluo orange, white/red, red/white.  
Sizes: 48 - 64

Realizzata con nomex e compound della migliore qualità.  
Estremamente leggera.  
Compound a 3 strati sottile.  
Massimo comfort e traspirabilità.  
Bande laterali e loghi in silicone.  
9 taglie standard disponibili.  
Design moderno ed essenziale.  
100% realizzata a mano in Italia.  
Omologazione: FIA 8856-2018  
Colori: night navy/arancione fluo, bianco/rosso, rosso/bianco.  
Taglie: 48 - 64



TUPROLTRED00

RED / WHITE  
ROSSO / BIANCO



TUPROLTWHT00

WHITE / RED  
BIANCO / ROSSO



SIZES / TAGLIE  
48-64

PLEASE NOTE  
ATTENZIONE

In each part number  
the two digits "00"  
indicate the size.  
In ogni codice prodotto  
le due cifre "00"  
indicano la taglia.

100% HAND MADE IN ITALY

MOMO Pro-Lite is completely customizable: choose every detail from the design, to the colors, the logos (which can be embroidered or printed through transfer technology), to the pockets, belt, stitching colors and more. Contact us on custom@momo.it to create together your perfect racing suit!

Anche Pro-Lite è completamente personalizzabile: dal design, ai colori, ai loghi (che possono essere sia ricamati che stampati con tecnologia transfer), alle varie tasche, cinture, colori delle cuciture e molto altro. Contattaci su custom@momo.it per creare insieme la tua tuta ideale!

### EXTERNAL FABRIC COLORS / COLORI TESSUTO ESTERNO

<b>WHITE "Cloud Dancer"</b> Pantone Textile: 11-4201 TPX Madeira Polyneon FR: 1801	<b>WHITE CREAM "Jet Stream"</b> Pantone Textile: 11-0605 TPX Madeira Polyneon FR: 1822	<b>LIGHT GREY "Lilac Hint"</b> Pantone Textile: 13-4105 TPX Madeira Polyneon FR: 1011	<b>DARK GREY "Steel Grey"</b> Pantone Textile: 18-4005 TPX Madeira Classic: 1041	<b>TORNADO GREY "Tornado"</b> Pantone Textile: 18-3907 TPX Madeira Classic: 1640	<b>BLACK "Pirate Black"</b> Pantone Textile: 19-0303 TPX Madeira Polyneon FR: 1800
<b>FLUO YELLOW</b> Pantone Textile: 17-1461 TPX Madeira Polyneon FR: 1823	<b>YELLOW "Butter Cup"</b> Pantone Textile: 12-0752 TPX Madeira Polyneon FR: 1924	<b>YELLOW "Cyber Yellow"</b> Pantone Textile: 14-0760 TPX Madeira Polyneon FR: 1924	<b>YELLOW "Lemon Chrome"</b> Pantone Textile: 13-0859 TPX Madeira Polyneon FR: 1624	<b>GOLD "Oak Buff"</b> Pantone Textile: 16-1144 TPX Madeira Polyneon FR: 1791	<b>ORANGE "Popsicle"</b> Pantone Textile: 15-1350 TPX Madeira Polyneon FR: 1678
<b>DARK ORANGE "Orangeade"</b> Pantone Textile: 17-1461 TPX Madeira Polyneon FR: 1621	<b>RED "High Risk Red"</b> Pantone Textile: 18-1763 TPX Madeira Classic: 1147	<b>RED "Aurora Red"</b> Pantone Textile: 18-1550 TPX Madeira Polyneon FR: 1839	<b>DARK RED "Syrah"</b> Pantone Textile: 19-1535 TPX Madeira Polyneon FR: 1784	<b>PINK "Azalea Pink"</b> Pantone Textile: 16-2126 TPX Madeira Polyneon FR: 1990	<b>PURPLE "Heliotrope"</b> Pantone Textile: 19-3737 TPX Madeira Polyneon FR: 1922
<b>FLUO GREEN "Green Flash"</b> Pantone Textile: 15-0146 TPX Madeira Polyneon FR: 1701	<b>LIGHT GREEN "Kelly Green"</b> Pantone Textile: 18-6138 TPX Madeira Polyneon FR: 1651	<b>PETRONAS GREEN "Dynasty Green"</b> Pantone Textile: 17-5330 TPX Madeira Polyneon FR: 1279	<b>GREEN "Alpine Green"</b> Pantone Textile: 18-5322 TPX Madeira Polyneon FR: 1985	<b>BLUE GREEN "Rancher Pine Grove"</b> Pantone Textile: 19-5406 TPX Madeira Polyneon FR:	<b>SUPER LIGHT BLUE "River Blue"</b> Pantone Textile: 15-4720 TPX Madeira Classic: 1094
<b>SKY BLUE "Blue Grotto"</b> Pantone Textile: 15-4421 TPX Madeira Polyneon FR: 1977	<b>LIGHT BLUE "Swedish Blue"</b> Pantone Textile: 18-4330 TPX Madeira Polyneon FR: 1296	<b>PETRO BLUE "Mosaic Blue"</b> Pantone Textile: 18-4528 TPX Madeira Polyneon FR: 1096	<b>ROYAL BLUE "Classic Blue"</b> Pantone Textile: 19-4052 TPX Madeira Polyneon FR: 1842	<b>PENSKE NAVY "Estate Blue"</b> Pantone Textile: 19-4027 TPX Madeira Polyneon FR: 1966	<b>NAVY BLUE "Navy Blazer"</b> Pantone Textile: 19-3923 TPX Madeira Polyneon FR: 1643

### KNIT (GUSSET) COLORS / COLORI MAGLINA

<b>WHITE "Gardenia"</b> Pantone Textile: 11-0604 TPX Madeira Polyneon FR: 1801	<b>GREY "High Rise"</b> Pantone Textile: 15-4101 TPX Madeira Polyneon FR: 1818	<b>BLACK "Anthracite"</b> Pantone Textile: 19-4007 TPX Madeira Polyneon FR: 1800	<b>NAVY "Dark Navy"</b> Pantone Textile: 19-4013 TPX Madeira Classic: 1643	<b>ROYAL "Sodalite Blue"</b> Pantone Textile: 19-3953 TPX Madeira Classic: 1167	<b>YELLOW "Lemon Chrome"</b> Pantone Textile: 13-0859 TPX Madeira Polyneon FR: 1624
<b>ORANGE "Scarlet Ibis"</b> Pantone Textile: 17-1361 TPX Madeira Polyneon FR: 1678	<b>RED "Flame Scarlet"</b> Pantone Textile: 18-1763 TPX Madeira Classic: 1147				

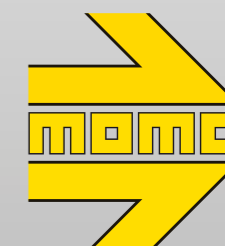
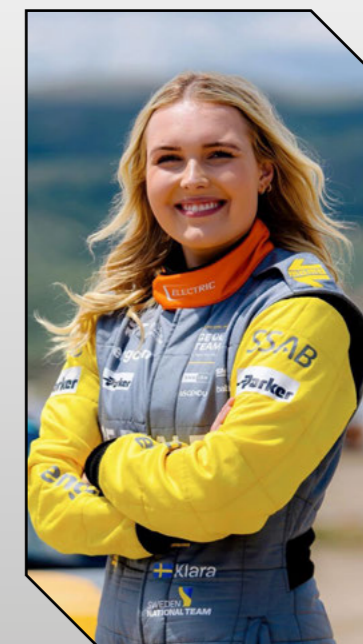
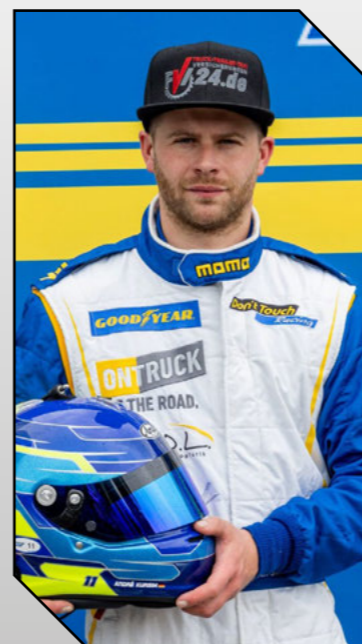



# UNDERWEAR MAGLIERIA

## UNDERWEAR MAGLIERIA

## UNDERWEAR MAGLIERIA



**FIA APPROVED**

BRAND: MOMO  
MODEL: PRO B  
HOM. NO: DC.321.23-B  
FIA STANDARD: 8856-2018

**PRO BALACLAVA  
SOTTOCASCO PRO**

- > Fireproof
- > FIA 8856-2018 homologated
- > Maximum comfort
- > Extremely light
- > Available in black or white
- > One size fits all

- > Ignifugo
- > Omologato FIA 8856-2018
- > Massimo comfort
- > Estremamente leggero
- > Disponibile in bianco o nero
- > Taglia unica

ONE  
SIZE  
TAGLIA  
UNICA

**BLACK / NERO**

MBALAPRO0BLK

**WHITE / BIANCO**

MBALAPRO0WHT

### CUSTOMIZED PERSONALIZZATO



MOMO offers the possibility to customize fireproof underwear by applying logos and graphics with a sophisticated transfer printing method.

MOMO offre la possibilità di personalizzare la maglieria ignifuga applicando loghi e grafiche con una sofisticata modalità di stampa transfer.



**FIA APPROVED**

BRAND: MOMO  
MODEL: PRO P  
HOM. NO: DC.323.23-L  
FIA STANDARD: 8856-2018

**PRO LONG JOHNS  
PANTALONE PRO**

- > Fireproof
- > FIA 8856-2018 homologated
- > Maximum comfort
- > Extremely light
- > Available in black or white
- > Sizes XS-2XL

- > Ignifugo
- > Omologato FIA 8856-2018
- > Massimo comfort
- > Estremamente leggero
- > Disponibile in bianco o nero
- > Taglie XS-2XL

XS-S

XL-2XL

**BLACK / NERO**

MLJPRBLK0XSS  
MLJPRBLK00ML  
MLJPRBLKXL2X

**WHITE / BIANCO**

MLJPRWHT0XSS  
MLJPRWHT00ML  
MLJPRWHTXL2X



**FIA APPROVED**

BRAND: MOMO  
MODEL: PRO M  
HOM. NO: DC.322.23-T  
FIA STANDARD: 8856-2018

**PRO HIGH COLLAR  
LUPETTO PRO**

- > Fireproof
- > FIA 8856-2018 homologated
- > Maximum comfort
- > Extremely light
- > Available in black or white
- > Sizes XS-2XL

- > Ignifugo
- > Omologato FIA 8856-2018
- > Massimo comfort
- > Estremamente leggero
- > Disponibili in bianco o nero
- > Taglie XS-2XL

XS-S

XL-2XL

**BLACK / NERO**

MLJPRBLK0XSS  
MLJPRBLK00ML  
MLJPRBLKXL2X

**WHITE / BIANCO**

MLJPRWHT0XSS  
MLJPRWHT00ML  
MLJPRWHTXL2X



**FIA APPROVED**

BRAND: MOMO  
MODEL: PRO C  
HOM. NO: DC.333.24-S  
FIA STANDARD: 8856-2018

**PRO SOCKS  
CALZE PRO**

- > Fireproof
- > FIA 8856-2018 homologated
- > Maximum comfort
- > Extremely light
- > Available in black or white
- > Sizes 38-46

- > Ignifughe
- > Omologate FIA 8856-2018
- > Massimo comfort
- > Estremamente leggero
- > Disponibili in bianco o nero
- > Taglie 38-46

38

46

**WHITE / BIANCO**

MSOPRWHT3839  
MSOPRWHT4041  
MSOPRWHT4243  
MSOPRWHT4445  
MSOPRWHT4600

**BLACK / NERO**

MSOPRBLK3839  
MSOPRBLK4041  
MSOPRBLK4243  
MSOPRBLK4445  
MSOPRBLK4600

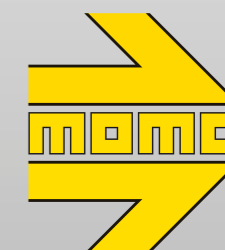





08  
13

MOMO Corsa Pro are the pinnacle of quality and functionality in a racing glove. Compliant to the FIA 8856-2018 homologation, and incorporating the latest 2022 revision for increased heat resistance, these gloves guarantee top-notch safety standards. Corsa Pro feature maximum wearability comfort thanks to their pre-curved structure, and a maximum grip thanks to the silicone inserts on the palm, as well as the touch screen functionality on the thumb and index fingers. Corsa Pro are available in 4 finishes, in perfect compatibility with our Pro-Lite suits.

MOMO Corsa Pro rappresenta l'apice di qualità e funzionalità in un guanto da corsa. Conforme all'omologazione FIA 8856-2018, incorpora anche l'ultima revisione del 2022 per una maggiore resistenza al calore, garantendo standard di sicurezza di altissimo livello. Corsa Pro offre il massimo comfort grazie alla sua struttura precurvata e il massimo del grip grazie agli inserti in silicone sul palmo, oltre alla funzionalità touch screen su pollice e indice. Corsa Pro è disponibile in 4 finiture, in perfetta compatibilità con le tute MOMO Pro-Lite.



GUCOPRORED00

RED / WHITE  
ROSSO / BIANCO



08  
13

MOMO Performance gloves feature a dynamic design based on the silhouettes of the most famous motorsport circuits. This model offers maximum wearability comfort and an excellent grip, thanks to the silicone inserts on the palm. Performance gloves are fireproof and FIA 8856-2018 homologated. Available in 4 finishes: red, navy, white and black.

I guanti MOMO Performance presentano un design dinamico che riprende le sagome dei più famosi circuiti del motorsport. Questo modello offre il massimo comfort nella vestibilità e un ottimo grip, grazie agli inserti in silicone sul palmo. I guanti Performance sono ignifughi e omologati FIA 8856-2018. Disponibili in 4 finiture: rosso, navy, bianco e nero.



GUPERFRED00

RED  
ROSSO



GUCOPROBLK00

BLACK / WHITE  
NERO / BIANCO



GUCOPRONNV00

NIGHT NAVY / ORANGE  
BLU NOTTE / ARANCIONE



GUCOPROWHT00

WHITE / RED  
BIANCO / ROSSO

SIZES / TAGLIE  
08-13

PLEASE NOTE  
ATTENZIONE

In each part number the two digits "00" indicate the size. In ogni codice prodotto le due cifre "00" indicano la taglia.

100% HAND MADE IN ITALY



GUPERFOBLK00

BLACK  
NERO



GUPERFONNV00

NIGHT NAVY  
BLU NOTTE



GUPERFOWHT00

WHITE  
BIANCO





# CORSA LITE

SHOES  
SCARPE

SHOES  
SCARPE

# PERFORMANCE



38  
46



**SCACOLRED00F**  
RED / BLACK / WHITE  
ROSSO / NERO / BIANCO

Corsa Lite is the top of the range driver boot developed by MOMO in fire resistant, breathable fabric, with kangaroo leather inserts. MOMO Corsa Lite is engineered and produced in accordance with the new FIA 8856-2018 regulation, essential requirement for a product dedicated to the professionals. Featuring an extraordinary 280\* gr weight MOMO Corsa Lite establishes itself among the lightest products on the market: this as the result of an accurate research of every product's element and a demanding materials' selection. The maximum weight's reduction is achieved also thanks to the graphic elements, entirely printed. The ultra light and ultra thin rubber sole has undergone rigorous testing for hydrocarbon resistance and abrasions and has a perfect fit. The breathable fabric, strengthened on the outside with a carbon look insert against abrasion, wraps comfortably the driver's foot and provides isolation from dust and other materials while ensuring maximum transpiration.

Corsa Lite è la scarpa da pilota top di gamma sviluppata da MOMO in tessuto ignifugo traspirante, con elementi in pelle di canguro. MOMO Corsa Lite è realizzata in conformità con la nuova normativa FIA 8856-2018, irrinunciabile requisito per un prodotto destinato ai professionisti del settore. Con uno straordinario peso di soli 280\* grammi si posiziona tra i prodotti più leggeri presenti sul mercato: questo risultato è stato raggiunto grazie ad un accurato studio di ogni componente del prodotto e alla esigente selezione dei materiali. La massima riduzione del peso è ottenuta anche grazie agli elementi grafici interamente stampati. La suola in gomma ultra sottile e ultra leggera è stata sottoposta a severi test per la resistenza agli idrocarburi e all'abrasione e si adatta perfettamente ad ogni tipo di calzatura. Il tessuto ignifugo, rinforzato nella parte esterna da un inserto effetto carbonio per garantire maggior resistenza all'abrasione, avvolge comodamente il piede del pilota isolandolo da polvere o altri materiali e allo stesso tempo assicura a lungo la massima traspirazione.



SIZES / TAGLIE  
38-46

PLEASE NOTE  
ATTENZIONE

In each part number  
the two digits "00"  
indicate the size.  
In ogni codice prodotto  
le due cifre "00"  
indicano la taglia.

**SCACOLBLU00F**

BLUE / BLACK / WHITE  
BLU / NERO / BIANCO

**SCACOLBLK00F**

BLACK / WHITE  
NERO / BIANCO

**SCACOLGRE00F**

GREY / BLACK / WHITE  
BLU / NERO / BIANCO

\* The weight refers to a single boot, size 42, with a ± 1% tolerance / \* Il peso si riferisce ad una singola scarpa, taglia 42, con una tolleranza di ± 1%.



38  
46



**SCAPERRED00F**  
RED / BLACK / WHITE  
ROSSO / NERO / BIANCO

Performance is the new MOMO racing shoe: perfect for drivers who seek maximum wearability comfort and sensitivity in the driving experience. Performance is a highly resistant shoe, produced in red, blue or black suede fabric, with soft white full-grain airleather inserts, and printed graphic elements. Other important features of this refined product are the side reinforcements in carbon finish, the sole designed for track use even over long distances, and the full-grain leather tongue. Performance is made in compliance with the FIA 8856-2018 homologation: an essential requirement for a product intended for professionals.

Performance è la nuova scarpa MOMO da pista: perfetta per i piloti che cercano il massimo comfort nella calzatura e sensibilità nella guida. Performance è una scarpa ad elevata resistenza, realizzata in tessuto scamosciato rosso, blu o nero, con inserti traforati in morbida pelle bovina pieno fiore bianca, ed elementi grafici stampati. Altre caratteristiche importanti di questo raffinato prodotto sono i rinforzi laterali in finitura di carbonio, la suola studiata per uso su pista anche per lunghe distanze, e la lingua in pelle bovina pieno fiore. Performance è realizzata in conformità con l'omologa FIA 8856-2018: irrinunciabile requisito per un prodotto destinato ai professionisti del settore.



**SCAPERBLU00F**

BLUE / BLACK / WHITE  
BLU / NERO / BIANCO

**SCAPERBLK00F**

BLACK / WHITE  
NERO / BIANCO

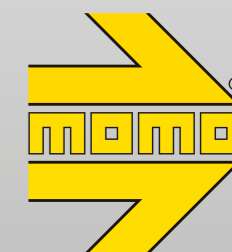



# MECHANIC MECCANICO

Not only for drivers: MOMO takes care of your entire team! To assist the team effectively, mechanics need to work with comfort and, above all, safety. That's why we've created a complete range of mechanic apparel, including fire-resistant gloves with extra padding and protections, safety shoes with in-depth postural studies, and finally, customizable fire-resistant, non-fire-resistant, or FIA-homologated suits. MOMO's mechanic suits are fully customizable in design and other details; contact us at [custom@momo.it](mailto:custom@momo.it) to create yours!

Non solo piloti: MOMO si occupa di tutto il tuo team! Per assistere la squadra al meglio, i meccanici devono essere in grado di muoversi con comodità e soprattutto sicurezza. È per questo che abbiamo creato una gamma completa di abbigliamento da meccanico, che include guanti ignifughi con imbottiture e protezioni extra, scarpe anti-infortunistiche su cui sono stati fatti approfonditi studi posturali, e infine tute personalizzate ignifughe, non ignifughe o omologate. Le tute meccanico MOMO sono totalmente personalizzabili nel design e nei dettagli; contattaci su [custom@momo.it](mailto:custom@momo.it) per creare quella della tua squadra!

24 > SHOES  
SCARPE

25 > GLOVES  
GUANTI







**ANATOMIC SOLE**  
The anatomical shape is inalterable for the entire lifetime of the shoe. La forma anatomica resta inalterata per tutta la durata della scarpa.



**SILVER STRIP DISCHARGE (S.S.D.)**  
Conductive tape, increases the dispersive capacity of the electrostatic charges. Nastro conduttivo, aumenta la capacità dispersiva delle cariche elettrostatiche.



**COMPOSHANK**  
Anti-torsion abs support. It improves stability on ladders and irregular floors. Supporto antitorsione in abs. Migliora la stabilità su scale e terreni irregolari.



**POWER CAP**  
Lightweight, metal free, athermic fiberglass and rubber toe cap (200 joule), en iso 22568 certified. Puntale in fibra di vetro e particolato di gomma, leggero, senza metalli, atermico (200 joule), certificato en iso 22568.



The MOMO Pit Stop mechanic shoe is highly breathable, water-repellent, resistant to laceration and chemical agents. With protective fiberglass toe cap and antistatic fabric insole, Pit Stop has been studied to grant maximum wearability comfort even after long periods of time, reducing the impact on the sole of the foot and guaranteeing an improved load distribution harmony. Thermoformed insole made in latex-foam fabric, antistatic, with anti-fungus activated carbons. Shock absorbing heel and plantar arch support. The outsole presents an elevated grip and it's resistant to wear, oils, hydrocarbons and slipping.

La scarpa meccanico MOMO Pit Stop è altamente traspirante, idrorepellente, resistente a lacerazioni e agenti chimici. Con puntale protettivo in fibra di vetro e soletta in materiale antistatico, Pit Stop è studiata per garantire il massimo del comfort nella vestibilità anche dopo lunghi periodi, riducendo l'impatto sulla pianta del piede e garantendo una migliore armonia nella distribuzione del carico. Soletta interna termoformata in schiuma di lattice, antistatica, con carboni attivi e antifungo. Tallone ammortizzato e supporto dell'arco plantare. Battistrada con elevato grip, resistente all'usura, agli oli e idrocarburi, e allo scivolamento.



#### BLACK / NERO

SCAPSTOPNER38  
SCAPSTOPNER39  
SCAPSTOPNER40  
SCAPSTOPNER41  
SCAPSTOPNER42  
SCAPSTOPNER43  
SCAPSTOPNER44  
SCAPSTOPNER45  
SCAPSTOPNER46

## GLOVES GUANTI



MOMO's fireproof mechanic gloves "Pit Stop" guarantee maximum protection from heat and collision thanks to features such as the protective coated silicone on the back of the hand, a structural foam padding on the knuckles and silicone grip inserts on the palm of the hand.

"Pit Stop", i guanti meccanico ignifughi MOMO, garantiscono la massima protezione dal calore e dagli urti grazie a caratteristiche come il silicone protettivo sulla parte posteriore della mano, un'imbottitura strutturale schiumata sulle nocche, e inserti in silicone sul palmo della mano per un grip superiore.

100% HAND MADE IN ITALY

#### BLACK / NERO

GMPITSTBLK0L  
GMPITSTBLK0M  
GMPITSTBLK0S  
GMPITSTBLKXL





# SIZE CHARTS

## TABELLE TAGLIE

### SIZE TAGLIE

### SIZING TAGLIE

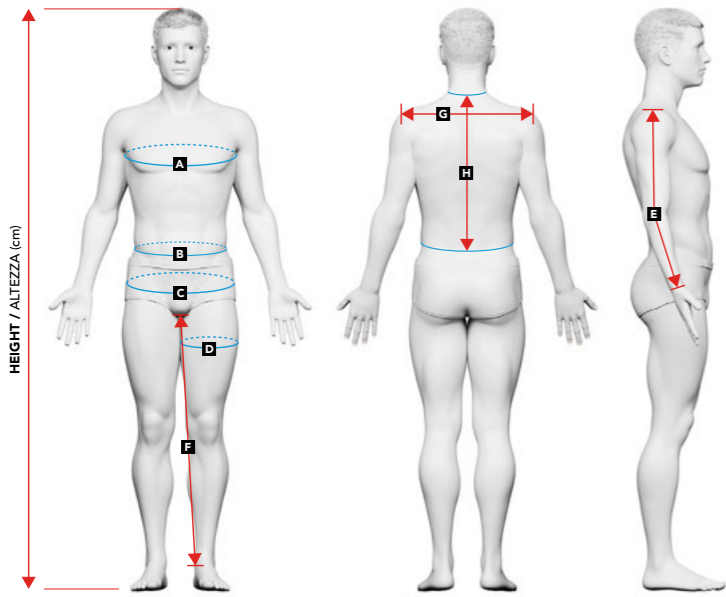

- A CHEST CIRCUMFERENCE - CIRCONFERENZA TORACE:** MEASURED UNDER THE ARMS AT THE WIDEST POINT, KEEPING THE ARMS ALONG THE BODY. MISURATA SOTTO LE BRACCIA NEL PUNTO PIÙ LARGO, CON LE BRACCIA DISTESE LUNGO IL CORPO.
- B WAIST CIRCUMFERENCE - CIRCONFERENZA VITA:** AT THE BELLY BUTTON LEVEL. ALL'ALTEZZA DELL'OMBELICO.
- C HIP CIRCUMFERENCE - CIRCONFERENZA FIANCHI:** AT THE LARGEST POINT OF THE BUTTOCKS. ALL'ALTEZZA DEI GLUTEI NEL PUNTO PIÙ LARGO.
- D THIGH CIRCUMFERENCE - CIRCONFERENZA COSCIA:** MEASURE FROM 5 cm DOWN THE GROIN. MISURARE PARTENDO DA 5 cm SOTTO L'INGUINE.
- E ARM LENGTH - LUNGHEZZA BRACCIO:** WITH STRAIGHT ARM, FROM THE SHOULDER POINT TO THE WRIST. A BRACCIO DISTESO, DALLA TESTA DELL'OMERO AL POLSO.
- F INSIDE LEG LENGTH - LUNGHEZZA INTERNO GAMBA:** INTERNAL PART OF THE LEG FROM THE GROIN TO THE INTERNAL ANKLE. PARTE INTERNA DELLA GAMBA DALL'INGUINE AL MALLEOLO INTERNO.
- G SHOULDER WIDTH - LARGHEZZA SPALLE:** FROM THE LEFT TO THE RIGHT SHOULDER POINT. DA UNA TESTA DELL'OMERO ALL'ALTRA.
- H BACK LENGTH - LUNGHEZZA SCHIENA:** FROM THE BASE OF THE NECK TO THE WAIST, AT THE BELLY BUTTON LEVEL. DALLA BASE POSTERIORE DEL COLLO ALLA VITA, IN CORRISPONDENZA DELL'OMBELICO.

**SCAN ME!**  FOLLOW OUR VIDEO TUTORIAL ON HOW TO MEASURE CORRECTLY. SEGUI IL NOSTRO VIDEO TUTORIAL SU COME PRENDERE LE MISURE.

HIGH COLLAR MEASUREMENTS TABLE - TABELLA TAGLIE LUPETTO

	EUROPEAN SIZE (cm) TAGLIA EUROPEA (cm)	XS/S	M/L	XL/XXL
<b>A LENGHT FROM SHOULDER (cm)</b> LUNGHEZZA DALLA SPALLA (cm)		73	74,5	78
<b>B CHEST WIDHT (cm)</b> LARGHEZZA PETTO (cm)		45,5	47	50
<b>C BOTTOM LENGTH (cm)</b> LUNGHEZZA FONDO (cm)		46	49,5	53
<b>D SLEEVE OPENING (cm)</b> GIROMANICA (cm)		26	27	28
<b>E COLLAR DEPTH (cm)</b> ALTEZZA COLLETO (cm)		5,5	5,5	5,5
<b>F NECK OPENING (cm)</b> APERTURA COLLO (cm)		17,5	18,5	20
<b>G SLEEVE LENGHT (cm)</b> LUNGHEZZA MANICA (cm)		73	75	78
<b>H SLEEVE OPENING (cm)</b> APERTURA MANICA (cm)		9,5	10,5	11

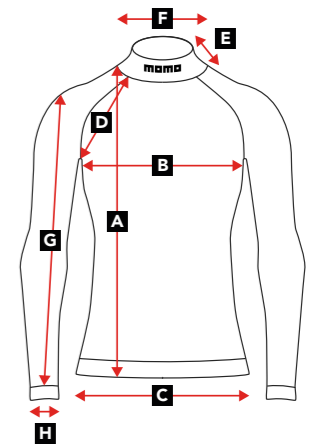

STANDARD SUIT MEASUREMENTS TABLE - TABELLA TAGLIE TUTA STANDARD

EUROPEAN SIZE TAGLIA EUROPEA	48	50	52	54	56	58	60	62	64
<b>WEIGHT (kg)</b> PESO (kg)	65 / 75	70 / 80	75 / 85	83 / 88	85 / 92	87 / 95	90 / 100	95 / 110	105 / 115
<b>HEIGHT (cm)</b> ALTEZZA (cm)	165 / 175	170 / 180	173 / 183	177 / 187	182 / 190	185 / 195	187 / 198	190 / 200	190 / 200
<b>A CHEST (cm)</b> TORACE (cm)	95 / 98	99 / 102	103 / 106	107 / 110	111 / 114	115 / 118	119 / 122	123 / 126	127 / 130
<b>B WAIST LINE (cm)</b> VITA (cm)	83 / 86	87 / 90	91 / 94	95 / 98	99 / 102	103 / 106	107 / 110	111 / 114	115 / 119
<b>C HIPS (cm)</b> BACINO (cm)	95 / 98	99 / 102	103 / 106	107 / 110	111 / 114	115 / 118	119 / 122	123 / 126	127 / 130
<b>D THIGH (cm)</b> COSCIA (cm)	53 / 56	55 / 58	57 / 60	59 / 62	61 / 63	63 / 66	65 / 68	67 / 70	68 / 72
<b>E ARM (cm)</b> BRACCIO (cm)	60 / 64	62 / 66	64 / 68	66 / 70	68 / 72	70 / 74	71 / 75	71 / 75	72 / 76
<b>F INSIDE LEG (cm)</b> INTERNO GAMBA (cm)	74 / 78	76 / 80	78 / 82	80 / 84	82 / 86	84 / 88	85 / 89	85 / 89	87 / 91
<b>G SHOULDERS (cm)</b> SPALLE (cm)	41 / 45	43 / 47	45 / 50	46 / 51	46 / 52	47 / 53	48 / 54	49 / 55	50 / 56
<b>H BACK (cm)</b> SCHIENA (cm)	46 / 50	47 / 51	48 / 52	48 / 53	49 / 54	49 / 55	50 / 56	51 / 56	52 / 58

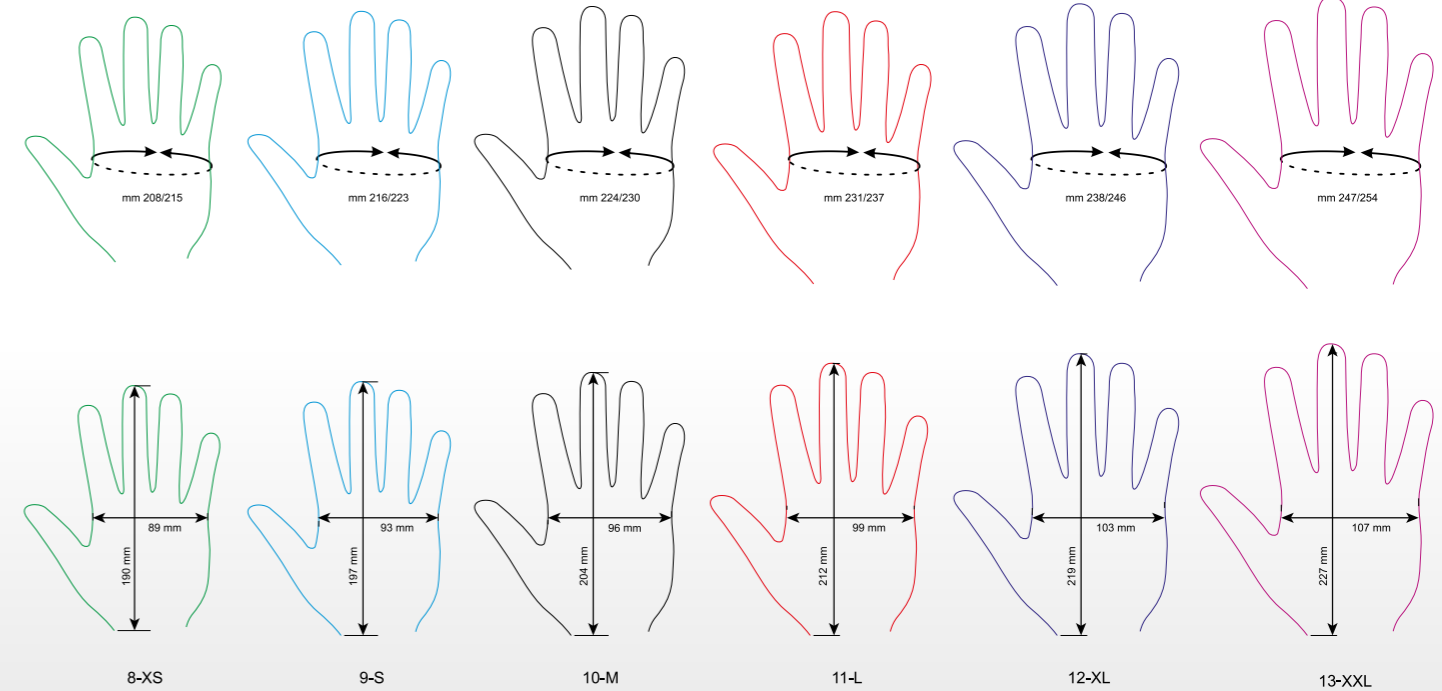

GLOVES MEASUREMENTS TABLE - TABELLA TAGLIE GUANTI

EUROPEAN SIZE TAGLIA EUROPEA	8	9	10	11	12	13
<b>USA SIZE TAGLIA USA</b>	XS	S	M	L	XL	XXL
<b>HAND CIRCUMFERENCE (mm)</b> CIRCONFERENZA MANO (mm)	208 / 215	216 / 233	224 / 230	231 / 237	238 / 246	247 / 254
<b>HAND WIDTH (mm)</b> LARGHEZZA MANO (mm)	89	93	96	99	103	107
<b>HAND HEIGHT (mm)</b> ALTEZZA MANO (mm)	190	197	204	212	219	227

**FOR A CORRECT MEASUREMENT:** PLEASE HOLD TAPE IN CENTER OF PALM AND MEASURE AROUND HAND.

**PER UNA CORRETTA MISURAZIONE:** SI PREGA DI TENERE FERMO IL METRO SNODABILE AL CENTRO DEL PALMO E GIRARLO ATTORNO ALLA MANO.

LONG JOHNS MEASUREMENTS TABLE - TABELLA TAGLIE PANTALONE

EUROPEAN SIZE TAGLIA EUROPEA	XS/S	M/L	XL/XXL
<b>A WAISTBAND WIDTH (cm)</b> LARGHEZZA VITA (cm)	33	36	37,5
<b>B RISE WITHOUT WAISTBAND WITH GUSSET (cm)</b> LUNGHEZZA CAVALLO SENZA CINTA (cm)	23,5	24,5	25,5
<b>C SIDE LENGTH (cm)</b> LUNGHEZZA LATERALE (cm)	97,5	101	104
<b>D INSEAM LENGTH (cm)</b> LUNGHEZZA INTERNO GAMBA (cm)	72	74	76
<b>E WAISTBAND DEPTH (cm)</b> ALTEZZA CINTURA (cm)	5	5	5,5
<b>F BOTTOM OPENING (cm)</b> APERTURA FONDO GAMBA (cm)	12	13,5	14,5

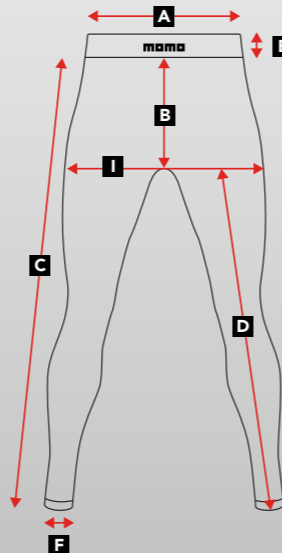

SHOES MEASUREMENTS TABLE - TABELLA TAGLIE SCARPE

EUROPEAN SIZE TAGLIA EUROPEA	38	39	40	41	42	43	44	45	46	47	48
<b>UK SIZE TAGLIA UK</b>	5	6	6 1/2	7	8	9	10	10 1/2	11	12	13
<b>LENGHT (cm)</b> LUNGHEZZA (cm)	25	25,5	26	27	27,5	28,1	28,7	29,5	30,2	31	31,5





# SEATS SEDILI

Thanks to our extensive experience in the field, MOMO seats are designed to ensure the highest standards of comfort and protect the driver during every driving session. Momo fiberglass seats are contoured to create an ergonomic seating position, providing proper support to different areas of the body, from the head to the back and down to the legs. The coating is made with high-quality technical fabrics (featuring fire-resistant and breathable materials) to offer increased well-being, grip, and safety. Furthermore, to better accommodate leg movements, the cushion is removable and split. In addition to technical features, design is also crucial: MOMO seats are meticulously crafted, presenting an attractive and innovative aesthetic. All MOMO seats are manufactured in compliance with FIA homologation standards.

Grazie alla nostra lunga esperienza nel settore, i sedili MOMO sono progettati per assicurare i più elevati standard di comfort e per proteggere il pilota durante ogni sessione di guida. I sedili in vetroresina MOMO sono sagomati per creare una seduta ergonomica e per dare il giusto supporto alle diverse zone del corpo, dalla testa alla schiena, fino alle gambe. Il rivestimento è realizzato con tessuti tecnici di alto livello (con materiali ignifughi e traspiranti), per offrire maggior benessere, aderenza e sicurezza. Inoltre, per assecondare al meglio i movimenti delle gambe, il cuscino è rimovibile e sdoppiato. Oltre alle caratteristiche tecniche, anche il design è importante: i sedili sono curati nei minimi dettagli e presentano un'estetica accattivante e innovativa. Tutti i sedili MOMO sono realizzati in conformità con l'omologata FIA.

30 > SEATS  
SEDILI

34 > SEAT BRACKETS  
STAFFE SEDILI

35 > SIZE CHART  
TABELLA MISURE







## SEATS SEDILI

STANDARD VERSION  
SERDAYTEVOBK

XL VERSION  
SERDAYTEVOXLL

XXL VERSION  
SERDAYTEVOXXL



① **Hans® compatible shoulder harness slot.**  
Fori cinture compatibili con sistema Hans®.

② **Airnet® technical fabric cushions for better airflow.**  
Cuscini in tessuto tecnico Airnet® per la massima traspirabilità.

③ **Removable double leg cushions.**  
Cuscino gambe rimovibile sdoppiato.

④ **Base cushion with Kinder Point anti-slip material.**  
Seduta in tessuto Kinder Point per la massima aderenza.

Composite ergonomic seat compatible with Hans® devices. Upholstered in breathable fire-retardant black fabric, the Daytona Evo's side head bolsters reduce the lateral movements of the helmet for additional support and protection. Exclusive Airnet® technical material covering the back cushions offer better airflow and quicker drying. Kinder Point on the seating area keeps the driver firmly in place while removable double leg cushions optimize support. External width for side mounts: 390 mm (standard version). Anti-sub seat belt opening. Side mount. Color: black. Weight: Standard 9,5 kgs / XL 10 kgs / XXL 12 kgs. FIA approved 8855-1999.

Sedile ergonomico in vetroresina, compatibile Hans®. Rivestito in materiale ignifugo e traspirante. La parte del sedile che contiene la testa del pilota è disegnata per ridurre i movimenti oscillatori laterali del casco offrendo supporto e protezione aggiuntivi. L'esclusivo tessuto tecnico Airnet® riveste ogni cuscino sullo schienale e il Kinder Point sulla seduta offre la massima aderenza. Cuscino gambe rimovibile e sdoppiato per ottimizzare il supporto. Larghezza esterna per aggancio staffe laterali: 390 mm (versione standard). 5 fori passaggio cinture. Fissaggio laterale. Colori: nero. Peso: versione standard 9,5 Kg / XL 10 Kg / XXL 12 Kg. Omologazione FIA 8855-1999.

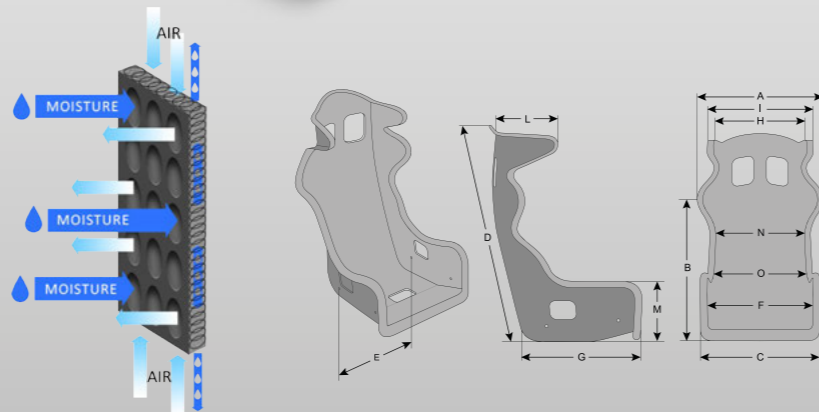

**AIRNET®**  
Airnet® is a technical fabric with incredible breathability and strength characteristics. With Airnet®, the driving comfort will be excellent, thanks to greater air flow in the seat back and to the most effective moisture permeability.

Airnet® è un tessuto tecnico dalle incredibili proprietà di traspirazione e resistenza. Con Airnet®, il comfort di guida sarà ai massimi livelli, grazie alla migliore circolazione dell'aria nello schienale del sedile e al più efficace assorbimento dell'umidità.

## SEATS SEDILI

STANDARD VERSION  
SERDAYTONABKL

XL VERSION  
SERDAYTONAXLL

XXL VERSION  
SERDAYTONAXXL



① **Hans® compatible shoulder harness slot.**  
Fori cinture compatibili con sistema Hans®.

② **Airnet® technical fabric cushions for better airflow.**  
Cuscini in tessuto tecnico Airnet® per la massima traspirabilità.

③ **Removable double leg cushions.**  
Cuscino gambe rimovibile sdoppiato.

④ **Base cushion with Kinder Point anti-slip material.**  
Seduta in tessuto Kinder Point per la massima aderenza.

The MOMO Daytona composite ergonomic seat is Hans® compatible. Side head bolsters support and protect the driver's head while reducing lateral movements. Revolutionary Airnet® technical material covers the seat's back for quicker drying. For added safety, the Daytona's fabric is fire retardant. Kinder Point on the seating area keeps the driver firmly seated. Removable double leg cushions enhance support. External width for side mounts: 390 mm (standard version). Anti-Sub seat belt opening. Side mount. Weight: Standard 9,5 kgs / XL 10 kgs / XXL 12 kgs. FIA approved 8855-1999.

Sedile ergonomico in vetroresina, compatibile Hans®. Rivestito in materiale ignifugo e traspirante. La parte del sedile che contiene la testa del pilota è disegnata per ridurre i movimenti oscillatori laterali del casco offrendo supporto e protezione aggiuntivi. L'esclusivo tessuto tecnico Airnet® riveste la parte centrale dello schienale e il Kinder Point sulla seduta offre la massima aderenza. Cuscino gambe rimovibile e sdoppiato per ottimizzare il supporto. Larghezza esterna per aggancio staffe laterali: 390 mm (versione standard). 5 fori passaggio cinture. Fissaggio laterale. Colori: nero. Peso: versione standard 9,5 Kg / XL 10 Kg / XXL 12 Kg. Omologazione FIA 8855-1999.

Tabella misure (mm) - Size chart (mm)

A	A "INTERNO" A "INNER"	B	C	D	E	F	G	H	I	L	M	N	O	kg*	VERSIONE VERSION
580	520	580	470	880	410	400	480	340	415	290	220	360	390	9,5	DAYTONA EVO / DAYTONA
600	550	600	480	910	425	415	480	385	465	290	220	370	410	10	DAYTONA EVO XL / DAYTONA XL
N/A	550	605	505	920	450	435	485	385	475	295	220	370	430	12	DAYTONA EVO XXL / DAYTONA XXL

\* Il peso si riferisce al sedile completo (tolleranza 10%)  
\* The weight refers to the complete seat (tolerance of 10%)





# SUPER CUP



① **Hans® compatible shoulder harness slot.**  
Fori cinture compatibili con sistema Hans®.

② **Airnet® technical fabric back for better airflow.**  
Schienale in tessuto tecnico Airnet® per la massima traspirabilità.

③ **Removable double leg cushions.**  
Cuscino gambe rimovibile sdoppiato.

④ **Base cushion with Kinder Point anti-slip material.**  
Seduta in tessuto Kinder Point per la massima aderenza.



Sedile in vetroresina compatibile Hans® per utilizzo su pista. Scocca posteriore a vista, rivestimento anteriore in tessuto. L'esclusivo tessuto tecnico Airnet® riveste l'area centrale dello schienale e il Kinder Point sulla seduta offre la massima aderenza. Cuscino gambe rimovibile e sdoppiato per ottimizzare il supporto assecondando i diversi movimenti delle gambe destra e sinistra. 5 fori passaggio cinture. Fissaggio laterale. Colore: nero. Peso: versione standard 8,9 kg, versione XL 10,2 Kg. Omologazione FIA 8855-1999.

Hans® compatible fiberglass seat. Seat shell visible on the rear, front portion upholstered in black fabric. The exclusive Airnet® technical material covers the central area on the back, and Kinder Point on the seating area provides the best possible grip. Removable double leg cushion to optimize support. 5 seat belt openings. Side mount. Color: black. Weight: standard version 8,9 kgs, XL version 10,2 kgs. FIA approved 8855-1999.



Tabella misure (mm) - Size chart (mm)

A	A "INTERNO" A "INNER"	B	C	D	E	F	G	H	I	L	M	N	O	kg*
570	N/A	540	470	880	400	410	450	N/A	N/A	N/A	N/A	365	400	8,9

\* Il peso si riferisce al sedile completo (tolleranza 10%)  
\* The weight refers to the complete seat (tolerance of 10%)

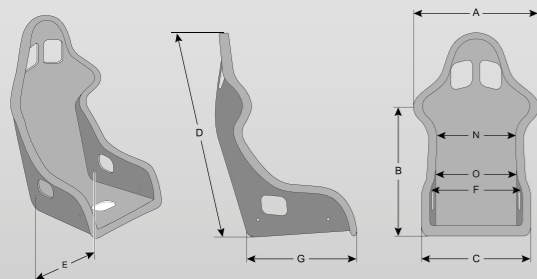

## SEATS SEDILI

SERSUPCUPBLKL

## SEATS SEDILI

SERSTARTBLK0L

# START



① **Hans® compatible shoulder harness slot.**  
Fori cinture compatibili con sistema Hans®.

② **Shell entirely fabric-coated.**  
Scocca interamente rivestita in tessuto.



Fiberglass shell  
Hans® compatible  
5 seat belt openings  
4 side mounts  
Weight: 8.3 kgs  
Color: black  
FIA approved 8855-1999

Scocca in vetroresina  
Compatibile Hans®  
5 fori passaggio cinture  
4 attacchi laterali  
Peso: 8,3 kg  
Colore: nero  
Omologazione FIA 8855-1999



Tabella misure (mm) - Size chart (mm)

A	A "INTERNO" A "INNER"	B	C	D	E	F	G	H	I	L	M	N	O	kg*
570	N/A	560	520	880	400	395	500	N/A	N/A	N/A	N/A	345	385	8,3

\* Il peso si riferisce al sedile completo (tolleranza 10%)  
\* The weight refers to the complete seat (tolerance of 10%)



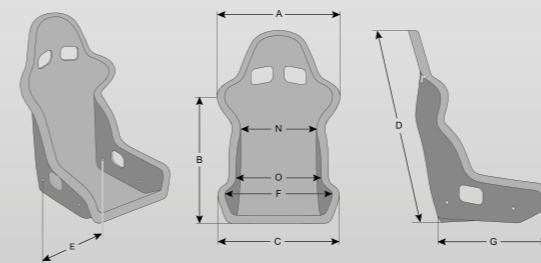

# SEAT BRACKETS

## STAFFE SEDILI

SEATS  
SEDILI

STAFSEDAC3BK

SEATS  
SEDILI

# SIZE CHART

## TABELLA MISURE

FIA APPENDIX J ART. 253



The MOMO seat brackets are made of 3 mm thick steel with black powder coated finish. Comply with Appendix J - Article 253 of the FIA International Sporting Code and are compatible with all MOMO seats homologated according to FIA 8855-1999. It is possible to adjust longitudinally, in height and angle the seat position using the pattern of holes on each brackets.

Le staffe sedili MOMO sono realizzate in acciaio con spessore 3 mm e verniciate a polvere di colore nero. Conformi all'Appendix J - Article 253 dell'International Sporting Code di FIA e compatibili con tutti i sedili MOMO omologati secondo la normativa FIA 8855-1999. E' possibile variare longitudinalmente, in altezza e l'angolo di seduta del sedile sfruttando il pattern di fori presenti sulle staffe.

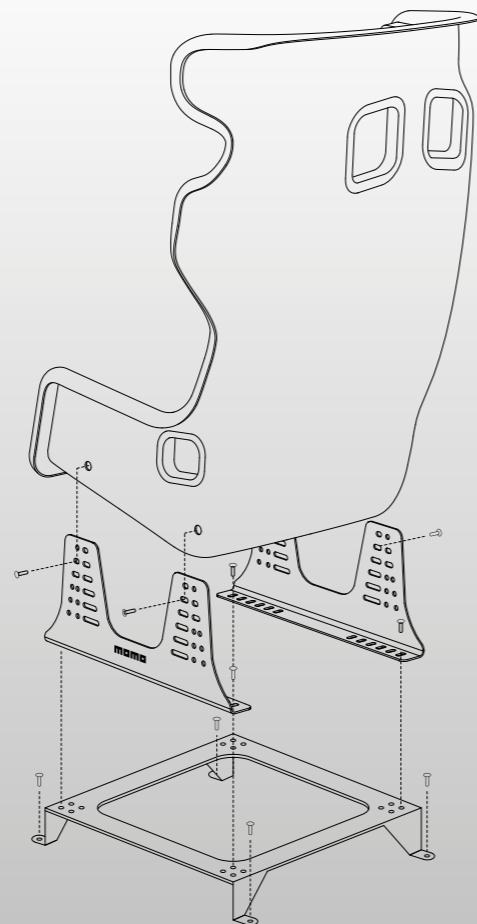
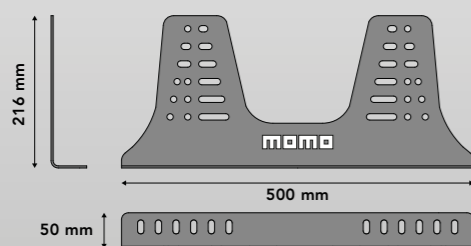

DAYTONA EVO

DAYTONA

SUPER CUP

START

Tabella misure (mm) - Size chart (mm)

A	A "INTERNO" A "INNER"	B	C	D	E	F	G	H	I	L	M	N	O	kg*	VERSIONE VERSION
580	520	580	470	880	410	400	480	340	415	290	220	360	390	9,5	DAYTONA EVO
600	550	600	480	910	425	415	480	385	465	290	220	370	410	10	DAYTONA EVO XL
N/A	550	605	505	920	450	435	485	385	475	295	220	370	430	12	DAYTONA EVO XXL
580	520	580	470	880	410	400	480	340	415	290	220	360	390	9,5	DAYTONA
600	550	600	480	910	425	415	480	385	465	290	220	370	410	10	DAYTONA XL
N/A	550	605	505	920	450	435	485	385	475	295	220	370	430	12	DAYTONA XXL
570	N/A	540	470	880	400	410	450	N/A	N/A	N/A	N/A	365	400	8,9	SUPER CUP
570	N/A	560	520	880	400	395	500	N/A	N/A	N/A	N/A	345	385	8,3	START

LEGEND

- A external max width at shoulders
- B seat bottom to mid shoulders
- C external max width of side bolsters
- D total height of seat back
- E seat bottom max external width
- F seat inner width (belt holes area)
- G bottom length
- H internal width between side head protections
- I external width between side head protections
- L depth of head laterl side
- M minimum height of lateral side
- N seat back width
- O seat side width

LEGENDA

- A larghezza massima esterna spalle
- B da fondo sedile a mezzera spalle
- C larghezza massima esterna zona gambe
- D altezza massima dal fondo
- E larghezza max esterna (zona attacchi laterali)
- F larghezza interna sedile (zona plastica cintura)
- G lunghezza seduta
- H larghezza interna poggiatesta
- I larghezza esterna poggiatesta
- L profondità delle protezioni laterali
- M altezza minima fianco laterale
- N larghezza schiena
- O larghezza laterale

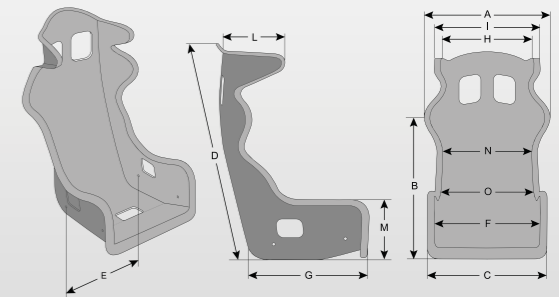

The following measurements are given as a guide. Actual measurements may vary to accomodate. \* The weight refers to the complete seat (tolerance of 10%)  
Le misure riportate in tabella sono fornite esclusivamente a titolo indicativo, potranno subire variazioni a seconda delle esigenze di lavorazione. \* Il peso si riferisce al sedile completo (tolleranza 10%)





# STEERING WHEELS VOLANTI

How do you become one of the undisputed leaders in the world of motorsports? For MOMO, that distinction is earned through hundreds of victories over decades on the racetrack. That title is also earned thanks to the enthusiastic support of the most prestigious drivers and teams from professional series around the world. This well-earned reputation is the inspiration behind the MOMO racing steering wheels collection that includes steering wheels used by demanding race professionals that continue to help solidify MOMO's place in racing history. Engineered according to the specific driver's needs, the entire steering wheels collection is wrapped in Italian suede, the best choice for motorsports.

L'esperienza decennale acquisita da MOMO sul campo gara e le numerose vittorie ottenute con i più prestigiosi team e piloti l'hanno resa leader indiscussa nel mondo del motorsport. Ad oggi la gamma di volanti racing MOMO ha al suo interno una varietà di modelli per soddisfare i piloti professionisti più esigenti: volanti Turismo, GT, rally, drifting e i celebri volanti formula che hanno fatto la storia di MOMO. Le caratteristiche strutturali di ogni modello sono progettate per adattarsi perfettamente alle esigenze specifiche del pilota. L'intera gamma racing è realizzata con l'incollatura della pelle alla corona per fornire il comfort di un'impugnatura senza cuciture e tutti i modelli sono offerti nella variante in pelle scamosciata, dal gusto fortemente racing.

**38 > RALLY**  
RALLY

**43 > GT-TOURING**  
GRAND TURISMO

**49 > FORMULA**  
FORMULA

**57 > ACCESSORIES**  
ACCESSORI

 **Steering wheel diameter (mm)**  
Diametro volante (mm)

 **Grip section (mm)**  
Sezione impugnatura (mm)

 **Dish (mm)**  
Caliciatura (mm)

 **Back finger grooves**  
Corona posteriore anatomica

 **Product equipped with NFC technology**  
Prodotto dotato di tecnologia NFC

Please note that all MOMO steering wheels are hand made and may display a small degree of variance against the listed specifications.  
Tutti i volanti MOMO sono realizzati artigianalmente e possono presentare lievi differenze rispetto alle specifiche tecniche.





# MOD. 07

## RALLY STEERING WHEELS VOLANTI RALLY

Ø 350 mm

**BLACK SUEDE**  
PELLE SCAMOSCIATA NERA  
11111811311R

**BLACK LEATHER**  
PELLE NERA  
11111811312R



Ø 350 mm



29x30 mm



72 mm



Cutouts in the spokes make the MOD. 07 lighter to improve driving performance. With a 72 mm dish, the size delivers full control. Black leather or suede are glued to the rim instead of stitched for optimal driving and improved durability. The grip specifically excludes anatomical elements for maximum steering flow.

La caratteristica foratura delle razze rende MOD. 07 ancor più leggero. La pelle, liscia o scamosciata incollata alla corona senza cuciture, ne migliorano l'esperienza di guida e la resistenza all'usura. La corona non presenta anatomicità, per garantire fluidità nelle manovre di sterzata.



100% HAND MADE IN ITALY

## RALLY STEERING WHEELS VOLANTI RALLY

Ø 350 mm

**BLACK SUEDE**  
**BLUE SPOKES**  
PELLE SCAMOSCIATA NERA  
RAZZE BLU  
11150085821R

**BLACK LEATHER**  
**BLUE SPOKES**  
PELLE NERA  
RAZZE BLU  
11150085811R

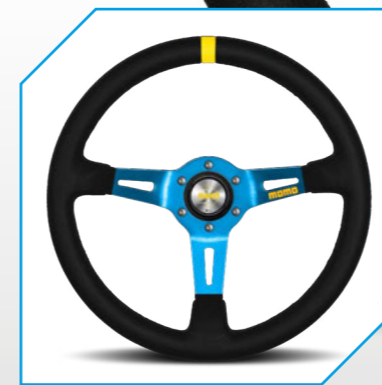

A best seller, the MOD. 08 steering wheel's size at 88 mm dish and 350 mm diameter was designed to meet the needs of rally lovers and saloon cars alike. Available in black suede or black leather, MOD.08 features anticorrosive black or electric blue aluminum spokes lightened with cutouts. A yellow leather position marker provides quick reference and a grip free of anatomical elements delivers maximum flow while driving.

88 mm di caliciatura e un diametro di 350 mm lo rendono uno dei volanti più venduti della gamma MOMO: scelta preferenziale non solo per gli esperti del mondo rally, al quale MOD. 08 è dedicato, ma anche per essere montato su berline sportive. Offerto in pelle liscia o scamosciata ha come tratto distintivo le losanghe che intagliano la razza in alluminio anticorrosivo alleggerendola e l'inserito giallo ad h 12 per segnalare sempre al pilota la posizione delle ruote. Disponibile con razza anodizzata nera o blu elettrico. La corona non presenta anatomicità, per garantire fluidità nelle manovre di sterzata soprattutto nel drifting.



MOMO MOTORSPORT COLLECTION 2024

# MOD. 08

Ø 350 mm

**BLACK SUEDE**  
**BLACK SPOKES**  
PELLE SCAMOSCIATA NERA  
RAZZE NERE  
11150085221R

**BLACK LEATHER**  
**BLACK SPOKES**  
PELLE NERA  
RAZZE NERE  
11150085211R



Ø 350 mm



29x30 mm



88 mm





# MOD. 02

## RALLY STEERING WHEELS VOLANTI RALLY

Ø 350 mm

**BLACK SUEDE**  
PELLE SCAMOSCIATA NERA  
11102155213R

**BLACK LEATHER**  
PELLE NERA  
11102155214R



Ø 350 mm



28 mm



87 mm



The two spokes on the MOD. 02 rally steering wheel lighten its weight while providing more maneuverability and hand room with the absence of the bottom spoke. Deep 87 mm dish and 350 mm diameter.

Volante rally a due razze, ancora più alleggerito nella struttura e con uno spazio di manovra maggiore grazie all'assenza della razza centrale inferiore. Caliciatura profonda 87 mm e diametro 350 mm.



100% HAND MADE IN ITALY

## RALLY STEERING WHEELS VOLANTI RALLY

Ø 350 mm

**BLACK SUEDE**  
**BLUE SPOKES**  
PELLE SCAMOSCIATA NERA  
RAZZE BLUE  
11150405811R

**BLACK LEATHER**  
**BLUE SPOKES**  
PELLE NERA  
RAZZE BLU  
11150405811R

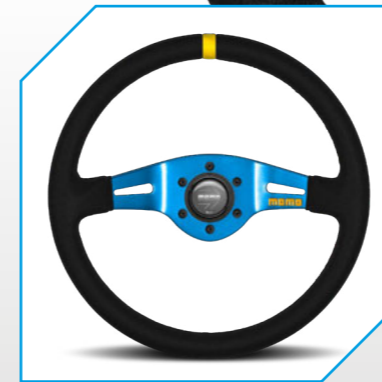

Ø 350 mm

**BLACK SUEDE**  
**BLACK SPOKES**  
PELLE SCAMOSCIATA NERA  
RAZZE NERE  
11150405211R

**BLACK LEATHER**  
**BLACK SPOKES**  
PELLE NERA  
RAZZE NERE  
11150405212R



Ø 350 mm



28 mm



70 mm



With only two spokes, the MOD. 03 is lighter and easier to maneuver. Available in black leather or suede with anodized black or electric blue spokes. The yellow leather insert provides a quick reference guide for the steering wheel's position.

Volante rally a due razze, ancora più alleggerito nella struttura e con uno spazio di manovra maggiore. Disponibile in pelle nera liscia o scamosciata, con razza anodizzata nera o blu elettrico, entrambe con inserto in pelle gialla per indicare al pilota l'esatta posizione delle ruote.



MOMO MOTORSPORT COLLECTION 2024



Ø 330 mm

**BLACK SUEDE**  
PELLE SCAMOSCIATA NERA  
VRDRIFT33BLKR



Ø 330 mm



30 mm



88 mm



Ø 320 mm

**BLACK SUEDE**  
PELLE SCAMOSCIATA NERA  
VR30C32SUBLKR

**BLACK SUEDE WITH BUTTONS**  
PELLE SCAMOSCIATA NERA CON BOTTONI  
VR30B32BKNEWR



Ø 320 mm



Ø 280 mm



35x25 mm



39 mm



The name speaks for itself! MOMO Drifting is designed to deliver better grip and handling in competitions and spirited driving. With a deep 88 mm dish, 330 mm diameter, MOMO Drifting delivers the control you need in even the most extreme driving conditions. The twin yellow center stripes at the top of the steering wheel provide a quick reference guide for drivers. Anodized matt anthracite spoke.

Il nome parla per sé: volante per competizione Drifting in pelle scamosciata nera. La calciatura profonda - 88 mm - e il diametro di 330 mm consentono un pieno controllo delle manovre di sterzata anche nelle condizioni più estreme. Il doppio inserto in pelle gialla segnala con maggior precisione la posizione delle ruote al pilota. Razza anodizzata antracite opaco.

MOD. 30 steering wheel is ideal for Sedan and GT drivers looking for maximum control. The anatomic design features spokes and thumb rests to better fit the driver's grip preference. The flat bottom design makes entering the cockpit easier while increasing leg clearance especially for quicker steering is required instead of full rotation for the wheel. Also available in two-button version.

Volante ad utilizzo Turismo e GT, presenta una forte anatomicità della corona per garantire il massimo controllo al pilota. Il fondo piatto agevola l'entrata nell'abitacolo e riduce l'ingombro del volante rispetto alle gambe del pilota, specialmente quando non è necessaria una piena rotazione del volante ma sono preferite rapide manovre di sterzata. Disponibile anche in versione con due pulsanti.





# MOD. 69

## GT-TOURING STEERING WHEELS VOLANTI GRAND TURISMO

Ø 350 mm

**BLACK SUEDE**  
PELLE SCAMOSCIATA NERA  
11111693521R



Ø 350 mm



32x30 mm



39 mm



Best suited for sedans and GTs, MOD. 69 features three black anodized aluminum spokes and a wheel wrapped in premium suede. Back finger grooves assist with maximum driving comfort. A yellow enamelled MOMO logo on the bottom spoke and horn button provide a pop of color.

Volante per utilizzo Turismo e GT rivestito in pelle scamosciata nera. La corona presenta anatomicità nella parte posteriore per il massimo comfort alla guida. La razza in alluminio nodizzato nero è impreziosita dal logo MOMO giallo smaltato.



100% HAND MADE IN ITALY

## GT-TOURING STEERING WHEELS VOLANTI GRAND TURISMO

Ø 320 mm

**BLACK SUEDE**  
PELLE SCAMOSCIATA NERA  
11111783321R

**BLACK LEATHER**  
PELLE NERA  
11111783311R



Ø 320 mm



23x35 mm



40 mm



Ø 350 mm

**BLACK SUEDE**  
PELLE SCAMOSCIATA NERA  
11111783521R

**BLACK LEATHER**  
PELLE NERA  
11111783511R



Ø 350 mm



23x34 mm



36 mm



One of the most popular choices for the GT and Sedan range, the MOD. 78 steering wheel features anticorrosional aluminum and is wrapped in either black leather or suede. The central rim offers an anatomic grip.

Uno dei volanti più popolari tra quelli ad utilizzo Turismo e GT. Struttura in alluminio anticorrosionale e rivestimento in pelle liscia o scamosciata. Corona anatomica nella parte centrale dell'impugnatura.

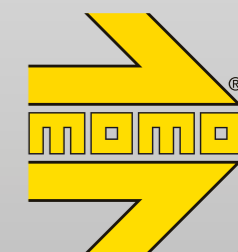

MOMO MOTORSPORT COLLECTION 2024



# MOD. 80

## GT-TOURING STEERING WHEELS VOLANTI GRAND TURISMO

Ø 350 mm

**BLACK SUEDE**  
PELLE SCAMOSCIATA NERA  
VR8035SUNEW

**BLACK LEATHER**  
PELLE NERA  
VR8035PLNEW



Ø 350 mm



35x26 mm



33 mm



## GT-TOURING STEERING WHEELS VOLANTI GRAND TURISMO

Ø 320 mm

**BLACK SUEDE**  
PELLE SCAMOSCIATA NERA  
VR88FB32SBLKR



Ø 320 mm



Ø 300 mm



27x35 mm



43 mm



Ø 350 mm

**BLACK SUEDE**  
PELLE SCAMOSCIATA NERA  
VR88FB35SBLKR



Ø 350 mm



Ø 325 mm



26x35 mm



43 mm



Featuring subtle anatomical elements to deliver a comfortable grip, the MOD. 80 features two classic buttons that can be wired to support various race systems.

MOD. 80 presenta degli elementi anatomici per offrire una presa confortevole, oltre ai due classici pulsanti che possono essere collegati per supportare vari sistemi di gara.

With racing-inspired cues, the MOD. 88 features a flat bottom design that makes getting behind the wheel easier by delivering more room between the driver's legs and the wheel. Three anodized spokes and a thick grip covered in premium suede help deliver maximum control in even the most extreme driving conditions.

Volante prototipo dalla caratteristica forma "Flat bottom" per agevolare l'ingresso in auto dove le ridotte distanza tra sedile, volante e rollbar, riducono lo spazio per le gambe del pilota. Controllo assicurato nella guida sportiva anche nelle condizioni più estreme.



100% HAND MADE IN ITALY

MOMO MOTORSPORT COLLECTION 2024



# MOD. 31

## GT-TOURING STEERING WHEELS VOLANTI GRAND TURISMO

Ø 320 mm

**BLACK SUEDE**  
PELLE SCAMOSCIATA NERA  
11150313221R



Ø 320 mm



28 mm



18 mm



Ø 340 mm

**BLACK SUEDE**  
PELLE SCAMOSCIATA NERA  
11150313421R



Ø 340 mm



28 mm



18 mm



## FORMULA STEERING WHEELS VOLANTI FORMULA

Ø 260 mm

**BLACK SUEDE**  
PELLE SCAMOSCIATA NERA  
11150112621R



Ø 260 mm



35x24 mm



00 mm



Ø 280 mm

**BLACK SUEDE**  
PELLE SCAMOSCIATA NERA  
11150112821R



Ø 280 mm



35x24 mm



00 mm



A competition steering wheel, MOD. 31 features an anticorrosive aluminum structure available in two diameters to optimally fit in different cars. The classic, simple round shape is covered in seamless suede.

Volante da competizione per utilizzo su prototipi. Struttura in alluminio anticorrosivo, rivestimento in pelle scamosciata senza cuciture e disponibilità di due diversi diametri ottimizzati per diverse applicazioni sui veicoli.

MOD.11 is a Formula steering wheel with a classic, three-spoke design. Available in two sizes, 260 and 280 mm, and featuring anatomical elements to improve driver comfort.

Volante formula disponibile in due diametri - 260 e 280 mm. La corona presenta anatomicità per offrire il massimo del comfort al pilota.



100% HAND MADE IN ITALY

MOMO MOTORSPORT COLLECTION 2024



# MOD. 26

## FORMULA STEERING WHEELS VOLANTI FORMULA

Ø 260 mm

**BLACK SUEDE**  
PELLE SCAMOSCIATA NERA  
11150262621R

**BLACK LEATHER**  
PELLE NERA  
11150262611R



Ø 260 mm



35x25 mm



00 mm



Ø 280 mm

**BLACK SUEDE**  
PELLE SCAMOSCIATA NERA  
11150262821R

Ø 290 mm

**BLACK SUEDE**  
PELLE SCAMOSCIATA NERA  
11150262921R



Ø 280 mm



Ø 290 mm



35x25 mm



00 mm



## FORMULA STEERING WHEELS VOLANTI FORMULA

# MOD. 29

Ø 270 mm

**BLACK SUEDE**  
PELLE SCAMOSCIATA NERA  
11150292721R



Ø 270 mm



Ø 215 mm



34x26 mm



00 mm



This timeless Formula design is available in three sizes to fit cockpit dimensions. This classic comes in 260, 280 and 290 mm diameters.

Un classico intramontabile del mondo formula, disponibile in tre diversi diametri - 260, 280 e 290 mm - per adattarsi perfettamente alle dimensioni dell'abitacolo.

The flat bottom and top design of this Formula steering wheel make the MOD. 29 an ideal choice for tighter cockpits. The flat bottom provides more leg room. The flat top improves visibility.

Volante formula: le dimensioni ridotte lo rendono perfetto per abitacoli compatti, il fondo piatto permette al pilota di aver maggior spazio per le gambe, mentre la parte superiore piatta garantisce maggior visibilità.

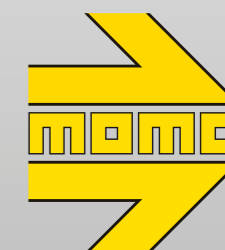

100% HAND MADE IN ITALY

MOMO MOTORSPORT COLLECTION 2024



# MOD. 27

## FORMULA STEERING WHEELS VOLANTI FORMULA

Ø 270 mm

**BLACK SUEDE**  
PELLE SCAMOSCIATA NERA  
11150272721R



Ø 270 mm



Ø 235 mm



35x25 mm



00 mm



Ø 290 mm

**BLACK SUEDE**  
PELLE SCAMOSCIATA NERA  
11150272921R



Ø 290 mm



Ø 244 mm



28x27 mm



00 mm



Ø 270 mm

**BLACK SUEDE**  
PELLE SCAMOSCIATA NERA  
11150272761R



Ø 270 mm



Ø 195 mm



36x26 mm



00 mm



Inspired by Formula racing, the MOD. 27 is a smaller size ideal for the tighter cockpits of single seat cars. The flat bottom design allows for more leg room. The grip is covered in black suede and is designed for quicker, more flexible steering. Available in two diameters, 270 and 290 mm.

Volante ad utilizzo formula: le dimensioni ridotte sono ottimizzate per il piccolo abitacolo di una monoposto, e il fondo piatto permette al pilota di aver maggior spazio per l'alloggiamento delle gambe. L'impugnatura consente rapide e agili manovre di sterzata. Disponibile in due diametri: 270 e 290 mm.

## FORMULA STEERING WHEELS VOLANTI FORMULA

# MOD. 27/C

This version of the MOD. 27/C is designed to deliver performance while improving instrument panel sightlines. The Formula steering wheel features a smaller dimension that makes it ideal for single seat cars with small cockpits. The flat bottom design also increases driver leg room.

Volante ad utilizzo formula: le dimensioni ridotte sono ottimizzate per il piccolo abitacolo di una monoposto, così come la tipica forma è appositamente progettata per aumentare la visibilità sul pannello di controllo della vettura.



100% HAND MADE IN ITALY

MOMO MOTORSPORT COLLECTION 2024



# MOD. 12

## FORMULA STEERING WHEELS VOLANTI FORMULA

Ø 250 mm

**BLACK SUEDE**  
PELLE SCAMOSCIATA NERA  
11150122521R



Ø 250 mm



Ø 200 mm



35x24 mm



00 mm



Ø 260 mm

**BLACK SUEDE**  
PELLE SCAMOSCIATA NERA  
11150122621R



Ø 260 mm



Ø 210 mm



35x24 mm



00 mm



## FORMULA STEERING WHEELS VOLANTI FORMULA

# MOD. 12/C

Ø 250 mm

**BLACK SUEDE**  
PELLE SCAMOSCIATA NERA  
11150122561R



Ø 250 mm



Ø 165 mm



35x27 mm



00 mm



With an oval shape designed to minimize vibrations, the MOD. 12 is a compact steering wheel offering ample leg clearance for Formula cars. Available in 250 and 260 mm sizes and covered in premium black suede.

La forma ovale riduce le vibrazioni rispetto ai classici volanti formula circolari: disponibile con diametro 250 o 260 mm, in pelle scamosciata con flat bottom per ottimizzare al meglio gli spazi nell'abitacolo.

This compact steering wheel, one of the smallest, features a top cutaway for better visibility for the smaller cockpit of Formula cars. The flat bottom makes it easier to get in and out of the vehicle and provides more leg room.

Uno dei volanti formula di dimensioni più ridotte - 250 mm. Tagliato nella parte superiore per incrementare la visibilità sul pannello di strumentazione. Tipica forma "flat bottom" per agevolare l'ingresso del pilota nella monoposto e ridurre l'ingombro del volante.

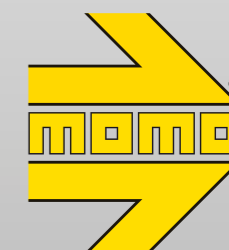
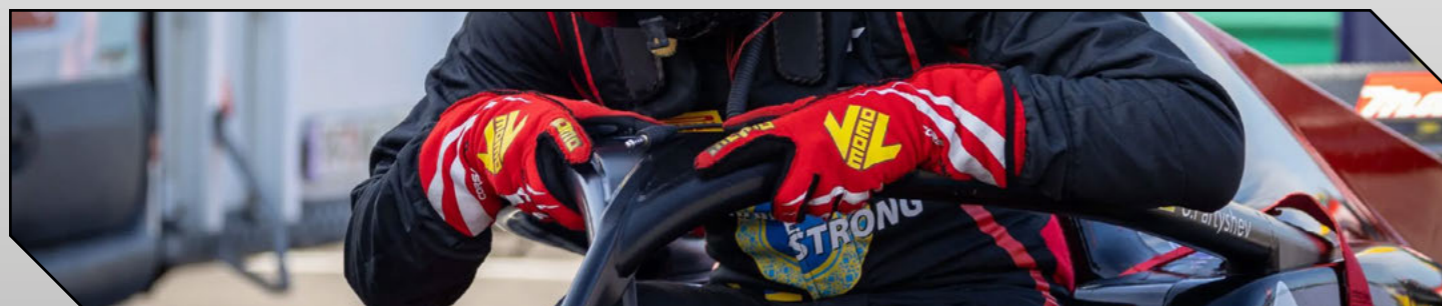

100% HAND MADE IN ITALY

MOMO MOTORSPORT COLLECTION 2024



# MOD. 101

## FORMULA STEERING WHEELS VOLANTI FORMULA

## ACCESSORIES ACCESSORI

# CARBON PLATE 4

Ø 290 mm

**BLACK SUEDE**  
PELLE SCAMOSCIATA NERA  
11150421111R



Ø 290 mm



Ø 180 mm



26x28 mm



Ø 00 mm



ACVCARBPLA4PL

MOD. 101 is designed to deliver performance while improving instrument panel sightlines. The Formula steering wheel features a smaller dimension that makes it ideal for single seat cars with small cockpits. Two buttons housing available.

MOD. 101 è progettato per fornire alte prestazioni e un'incrementata visuale della strumentazione. Le ridotte dimensioni lo rendono il volante ideale per equipaggiare il piccolo abitacolo di una monoposto. Disponibile l'alloggiamento per due pulsanti.

Manufactured in genuine carbon fiber, this plate allows up to 4 buttons (not included) and 6 drill points in this standard hub attachment.

Piastra porta pulsanti in fibra di carbonio, spessore 2,5 mm. Consente l'utilizzo fino a 4 pulsanti (non forniti). Foratura mozzo standard 6 fori.



100% HAND MADE IN ITALY

MOMO MOTORSPORT COLLECTION 2024



# ADVERTISING AND EVENTS COMUNICAZIONE ED EVENTI



VOLANTI DAL 1964

100% REALIZZATI A MANO IN ITALIA



MOMO's brand identity has been well defined and easily recognisable all over the world, for generations. Our Design Department works every day to develop advertising campaigns which can represent the brand at its best. Furthermore, every year MOMO attends the main international stages to launch new products, expand the commercial network and keep up with the newest trends.

L'identità del marchio MOMO è definita e riconoscibile in tutto il mondo, da generazioni. Il nostro Design Department lavora quotidianamente all'elaborazione di campagne pubblicitarie che possano rappresentare il marchio al meglio. MOMO ogni anno è inoltre presente sui principali palcoscenici internazionali per presentare i nuovi prodotti, espandere la rete commerciale ed essere sempre al passo con le nuove tendenze del settore.



IN THE INTEREST OF PRODUCT IMPROVEMENT, MOMO RESERVES THE RIGHT TO MAKE CHANGES TO THE CONSTRUCTION AND DESIGN OF ITS PRODUCTS WITHOUT PRIOR NOTIFICATION. MOMO SI RISERVA IL DIRITTO DI APPORTARE IN QUALSIASI MOMENTO MODIFICHE AI PRODOTTI DESCRITTI IN QUESTO CATALOGO PER RAGIONI DI NATURA TECNICA E COMMERCIALE.





ROAD WHEELS > STREET > HERITAGE > MOTORSPORT > TIRES



[momo.com](http://momo.com)

**MOMO SRL**

Via G. Bensi, 1/1,  
20152 Milano - Italia  
Tel: +39 02 424 112  
Mail: [info@momo.it](mailto:info@momo.it)

 @MomoOfficial

 @momo\_official